

# VL CONNECTOR (HIGH CURRENT TYPE)

6.2mm pitch/Disconnectable Crimp style connectors Wire-to-wire connectors  
(Combined use for both wire-to-wire and wire-to-board connections)

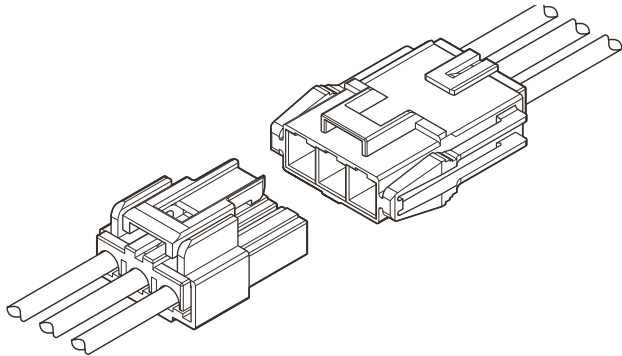

This VL connector is 6.2 mm pitch wire-to-wire and wire-to-board connector, designed for large current. The connector suitable for the large electric current has been realized by using highly-conducting material, so that the connection of large current circuit enables.

- Housing lances
- Retainer
- Suited for large current
- Panel lock

## Standards

- Recognized E60389
- Certified LR20812
- R9351103

## Specifications

- Current rating: 23 A AC, DC (Refer to the following table.)
- Voltage rating: 600 V AC, DC
- Temperature range: -25°C to +90°C  
(including temperature rise in applying electrical current)
- Contact resistance: Initial value/ 7 mΩ max.  
After environmental tests/ 10 mΩ max.
- Insulation resistance: 1,000 MΩ min.
- Withstanding voltage: 2,000 VAC/minute
- Applicable wire: AWG #20 to #12  
0.5 to 3.5 mm<sup>2</sup>
- Applicable panel thickness: 0.5 to 2.0 mm

\* In using the products, refer to "Handling Precaution for Terminal and Connector" described on our website (Technical documents of Product information page).

\* Contact JST for details.

\* RoHS2 compliance

Note: The current rating mentioned above is applied only in the combination of socket contact and pin contact for high current. When either is a normal product, please be careful because the current rating of the normal product is applied.

Current unit: A

No. of circuits	Wire size (AWG)				
	#12	#14	#16	#18	#20
1	23	18	15	11	9
2	23	18	15	11	9
3	22	17	14	10	8
4	21	16	13	9	8

## Panel layout and Assembly layout

<2, 3, 4 circuits (Single-row)>

Inner-housing lock

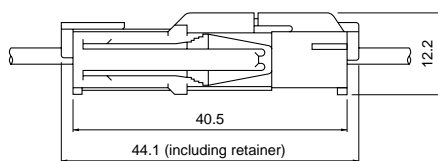

Outer-housing lock

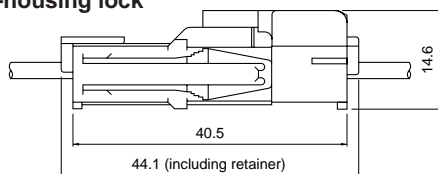

Shape I

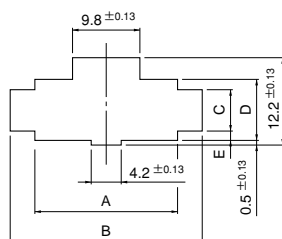

Shape II

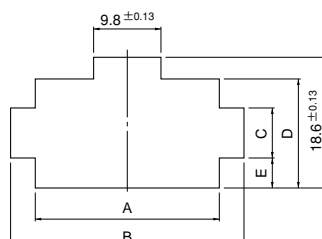

<4 circuits (Double-row)>

Inner-housing lock

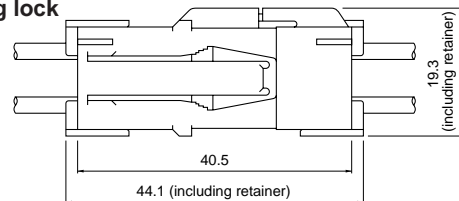

Outer-housing lock

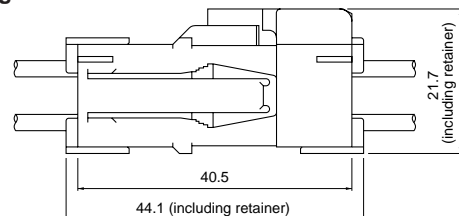

No. of circuits	Receptacle housing Model No.	Panel hole shape	Panel hole dimensions (mm)					Applicable panel thickness (mm)
			General tolerance A, B, D: ±0.13 C, E: ±0.1					
			A	B	C	D	E	
2	VLR-02V	I	13.8	20.6	5.7	8.5	1.4	0.5~2.0
3	VLR-03V	I	20.0	26.8	5.7	8.5	1.4	
4	VLR-04V	II	13.8	20.6	7.0	15.4	4.2	
4 (Single-row)	VLR-04VN	I	26.2	33.0	5.7	8.5	1.4	

- Note: 1. Punch holes in the panel according to the figures and table shown above. Burrs must be removed.  
2. The strength of the panel must be considered when punching two or more holes.  
3. The connector must be inserted from the same side as the hole is punched.

# VL CONNECTOR (HIGH CURRENT TYPE)

## Contact

### Pin contact

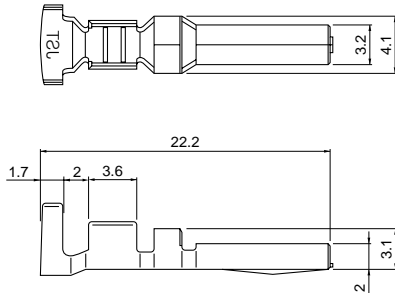

### Socket contact

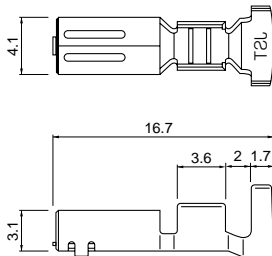

Model No.		Applicable wire		Insulation O.D. (mm)	Q'ty/reel
Pin contact	Socket contact	mm <sup>2</sup>	AWG #		
SVSM-61T-S2.0	SVSF-61T-S2.0	0.5~2.0	20~14	1.9~3.4	2,000
		0.5+0.5~0.75+1.25	20+20~18+16	1.9+1.9~2.1+2.7	
SVSM-81T-S2.0	SVSF-81T-S2.0	3.5	12	4.1	

### Material and Finish

Phosphor bronze, tin-plated (reflow treatment)

### RoHS2 compliance

Contact	Crimping machine	Applicator		
		Crimp applicator	Dies	Crimp applicator with dies
SVSM-61T-S2.0	AP-K2N	MKS-L	MK/SVF/M-61-20	APLMK SVF/M61-20
SVSF-61T-S2.0		—	—	—
SVSM-81T-S2.0		MKS-L	MK/SVF/M-81-20	APLMK SVF/M81-20
SVSF-81T-S2.0		—	—	—

Note: Contact JST for fully automatic crimping applicator.

## Contact position location numbers

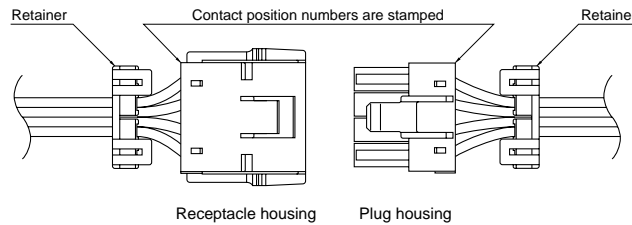

Receptacle housing

Plug housing

### Receptacle housing

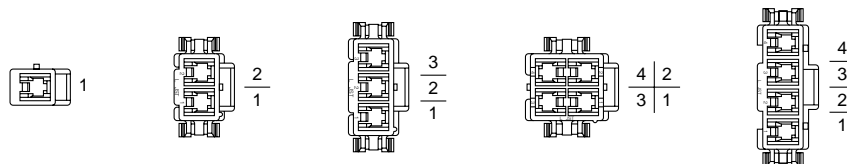

### Plug housing

#### <Inner-housing lock>

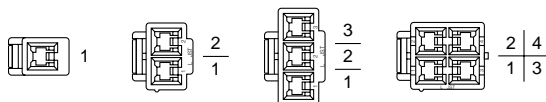

#### <Outer-housing lock>

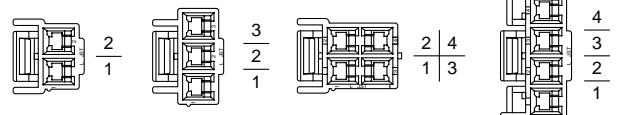

# VL CONNECTOR (HIGH CURRENT TYPE)

## Housing

Material: Housing...PA 66, UL94V-0, white  
Retainer...Glass-filled PA 66, UL94V-0, ivory

No. of circuits	Voltage rating	Current rating	Receptacle housing (for pin contact)	Plug housing (for socket contact)	Retainer
1	600V	23A	<b>VLR-01VF</b> (Without panel lock product) 	<b>VLP-01V</b> 	<b>VLS-01V</b> 
			Q'ty/ bag	Q'ty/ bag	Q'ty/ bag
2	600V	23A	<b>VLR-02V</b> 	<b>VLP-02V</b> 	<b>VLS-02V</b> (commonly used for 2-circuit housing and 4-circuit housing) 
			Q'ty/ bag	Q'ty/ bag	
2	600V	23A	<b>VLR-02VF</b> (Without panel lock product) 	<b>VLP-02V-1</b> 	1,000
			500	500	
3	600V	22A	<b>VLR-03V</b> 	<b>VLP-03V</b> 	<b>VLS-03V</b> 
			Q'ty/ bag	Q'ty/ bag	
3	600V	22A	<b>VLR-03VF</b> (Without panel lock product) 	<b>VLP-03V-1</b> 	1,000
			500	500	
4	600V	21A	<b>VLR-04V</b> 	<b>VLP-04V</b> 	<b>VLS-02V</b> 
			Q'ty/ bag	Q'ty/ bag	
		<b>VLR-04VF</b> (Without panel lock product) 	<b>VLP-04V-1</b> 	1,000	
500	500	1,000			
4	600V	21A	<b>VLR-04VN</b> 	<b>VLP-04VN-1</b> 	<b>VLS-08V</b> 
			Q'ty/ bag	Q'ty/ bag	Q'ty/ bag
4	600V	21A	500	500	1,000

RoHS2 compliance

Note: 1. Contact JST for special products.